

Rail-to-Rail I/O Op. Amp.

Features

- Single-supply operation: 2.0V to 5.5V
- Low supply current: 700 μ A
- Wide bandwidth: 3 MHz
- Slew rate: 1 V/ μ s
- No phase reversal
- Unity-gain stable
- Small 5-pin SOT-23-5 package

Applications

- Battery-Powered Instruments
- Portable Equipment
- Audio Signal Conditioning
- Multimedia Audio
- ASIC Input or Output Amplifier

Description

The SS8012G is a single-supply amplifier supporting rail-to-rail input and output. High output current makes these amplifiers excellent for driving either resistive or capacitive loads. AC performance is very good with 3.0MHz bandwidth.

The very low input bias currents allow the SS8012G to be used for integrators and diode amplification and other applications requiring low input bias current. The supply current is only 700 μ A per amplifier at 3.0V, allowing low current applications to control high current loads.

Applications include audio amplification for computers, sound ports, sound cards and set-top boxes. The SS8012G is very stable and capable of driving capacitive loads. The ability to swing rail-to-rail at the inputs and outputs enables designers to buffer CMOS ADC/DACs, ASICs or other wide output swing devices in single-supply systems.

Ordering Information

SS8012GTR : SS8012 in SOT-23-5 with Pb-free lead finish, shipped on tape and reel.

 **This device is only available with Pb-free lead finish (second-level interconnect).**

Pin Configuration

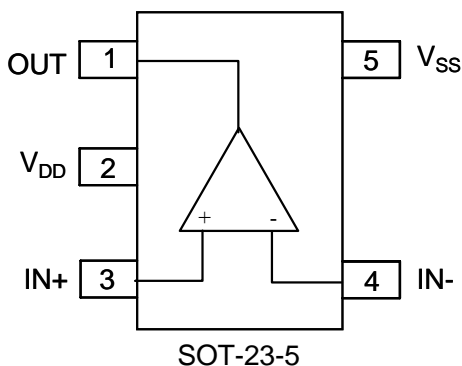

Typical Application Circuit

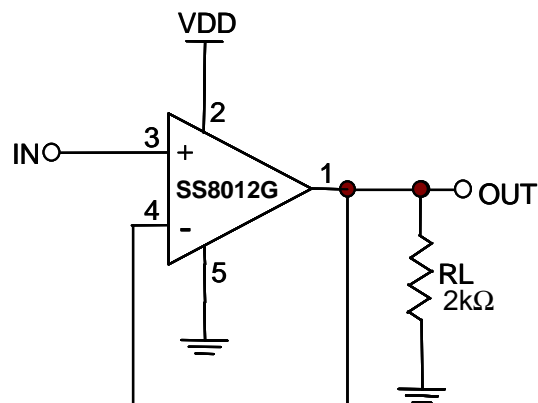

Absolute Maximum Ratings (Note1)

SYMBOL	PARAMETER	CONDITIONS	MIN.	MAX.	UNIT
V _{DD}	Supply voltage		0	7.0	V
T _{stg}	Storage temperature		-65	+150	°C
T _{amb}	Operating ambient temperature		0	+70	°C

Notes:

1. Absolute Maximum Ratings are limits beyond which damage to the device may occur.

Thermal Characteristics

SYMBOL	PARAMETER	VALUE	UNIT
R _{th ja}	Thermal resistance from junction to ambient in free air SOT-23-5	240	°C/W

Electrical Characteristics

V_{DD} = 2V, V_{SS} = 0V, T_{amb} = 25°C, R_L > 1MΩ, unless otherwise specified.

SYMBOL	PARAMETER	CONDITIONS	MIN.	TYP.	MAX.	UNIT
Supplies						
I _{DD}	Supply current	no load	-	0.13	0.4	mA
P _{tot}	Total power dissipation	no load	-	0.26	0.8	mW
DC Characteristics						
V _{I(OS)}	Input offset voltage			±1mV	±15	mV
V _{CM}	Common mode voltage		0	-	2.0	V
I _B	Input Bias Current			±0.05		nA
I _{OS}	Input Bias Current Offset			±0.05		nA
R _{IN}	Input Resistance			1000	-	MΩ
A _v	Open Loop Gain			95	-	dB
I _O	Maximum output current	V _{OUT} = ±V _{IN} × 90%	-	±12	-	mA
V _O	Output Voltage Swing	R _L = 2kΩ	0.04	-	1.96	V
PSRR	Power supply rejection ratio			50	-	dB
CMRR	Common-Mode Rejection Ratio			55		dB
AC Characteristics						
GBWP	Gain-Bandwidth Product	Open-loop; No Load	-	1.0	-	MHz
SR	Slew-Rate	Measured from 20% to 80% of 2V _{P-P} step		0.3		V/μs
PM	Phase Margin		-	60	-	deg

Electrical Characteristics

$V_{DD} = 3V$, $V_{SS} = 0V$, $T_{amb} = 25^{\circ}C$, $R_L = 1M\Omega$, unless otherwise specified.

SYMBOL	PARAMETER	CONDITIONS	MIN.	TYP.	MAX.	UNIT
Supplies						
I_{DD}	Supply current	no load	-	0.7	2.1	mA
P_{tot}	Total power dissipation	no load	-	2.1	6.3	mW
DC Characteristics						
$V_{I(OS)}$	Input offset voltage			± 1.5	± 15	mV
V_{CM}	Common mode voltage		0	-	3.0	V
I_B	Input Bias Current			± 0.05		nA
I_{OS}	Input Bias Current Offset			± 0.05		nA
R_{IN}	Input Resistance			1000	-	$M\Omega$
A_V	Open Loop Gain			90	-	dB
I_O	Maximum output current	$V_{OUT} = \pm V_{IN} \times 90\%$	-	± 27	-	mA
V_O	Output Voltage Swing	$R_L = 2k\Omega$	0.04	-	2.96	V
PSRR	Power supply rejection ratio			65	-	dB
CMRR	Common-Mode Rejection Ratio			55		dB
AC Characteristics						
GBWP	Gain-Bandwidth Product	Open-loop; No Load	-	3.0	-	MHz
SR	Slew-Rate	Measured from 20% to 80% of $5V_{P-P}$ step		1		V/ μs
PM	Phase Margin		-	60	-	deg

Electrical Characteristics

$V_{DD} = 5V$, $V_{SS} = 0V$, $T_{amb} = 25^{\circ}C$; $R_L = 1M\Omega$, unless otherwise specified.

SYMBOL	PARAMETER	CONDITIONS	MIN.	TYP.	MAX.	UNIT
Supplies						
I_{DD}	Supply current	no load	-	0.9	2.4	mA
P_{tot}	Total power dissipation	no load	-	4.5	12	mW
DC Characteristics						
$V_{I(OS)}$	Input offset voltage			± 3	± 15	mV
V_{CM}	Common mode voltage		0	-	5.0	V
I_B	Input Bias Current			± 0.05		nA
I_{OS}	Input Bias Current Offset			± 0.05		nA
R_{IN}	Input Resistance			1000	-	$M\Omega$
A_V	Open Loop Gain			65	-	dB
I_O	Maximum output current	$V_{OUT} = \pm V_{IN} \times 90\%$	-	± 60	-	mA
V_O	Output Voltage Swing	$R_L = 2k\Omega$	0.05	-	4.95	V
PSRR	Power supply rejection ratio			65	-	dB
CMRR	Common-Mode Rejection Ratio			45		dB
AC Characteristics						
GBWP	Gain-Bandwidth Product	Open-loop; No Load	-	13	-	MHz
SR	Slew-Rate	Measured from 10% to 90% of $5V_{P-P}$ step		6		V/ μs
PM	Phase Margin		-	60	-	deg

Large Signal Transient Response Characteristics

Test Condition: $T_A = 25^\circ\text{C}$, $A_V = 1$, $R_L = 2\text{k}\Omega$

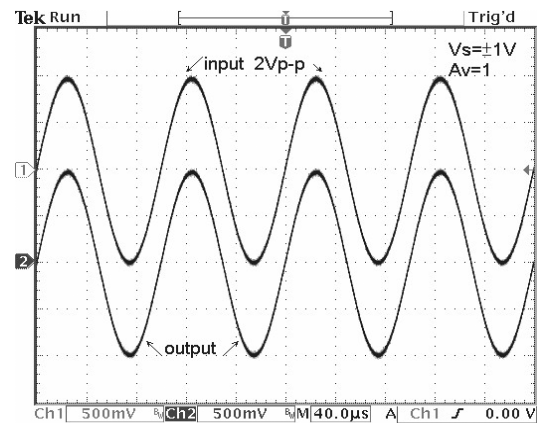
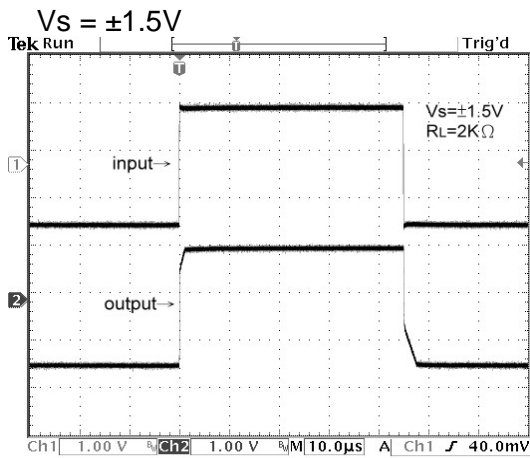
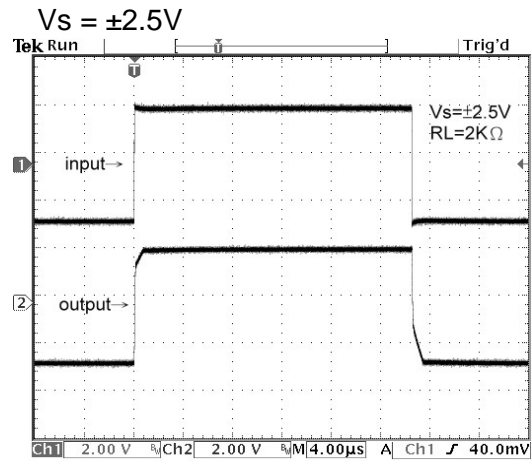
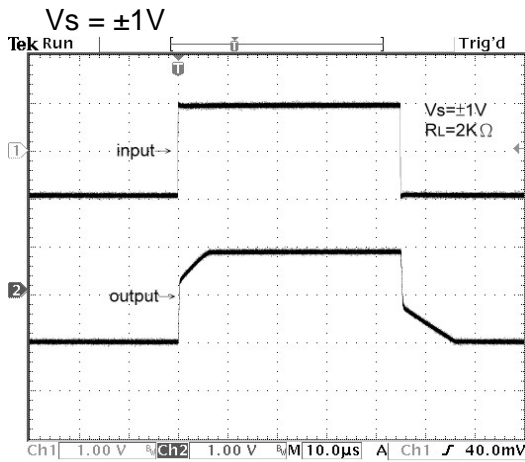

Operation with input beyond the rail

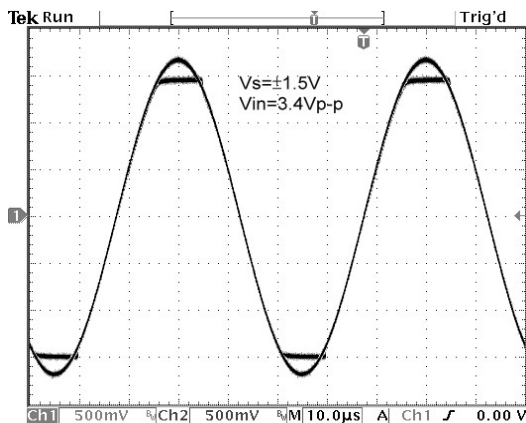

Small Signal Transient Response Characteristics

Test Condition: $T_A = 25^\circ\text{C}$, $A_V = 1$, $R_L = 2\text{k}\Omega$

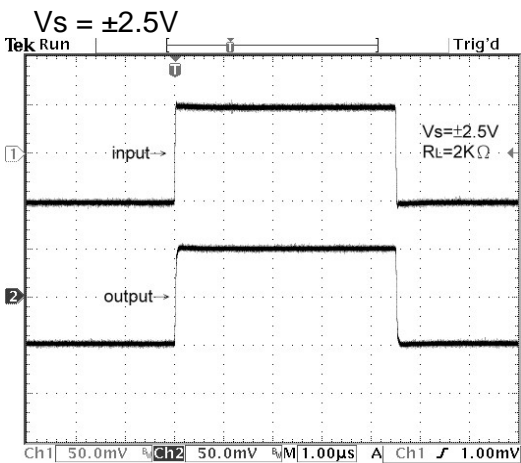
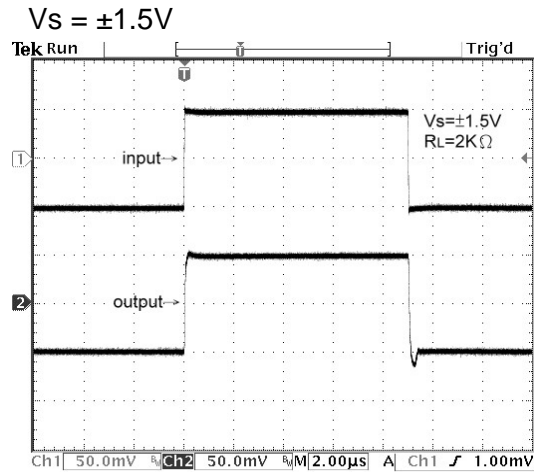
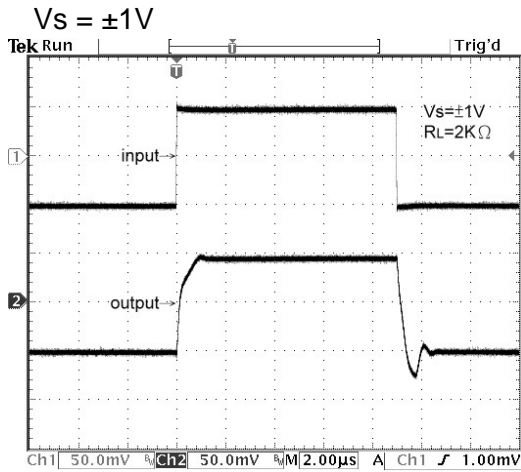

Test Condition: $V_S = \pm 1.5\text{V}$, $T_A = 25^\circ\text{C}$

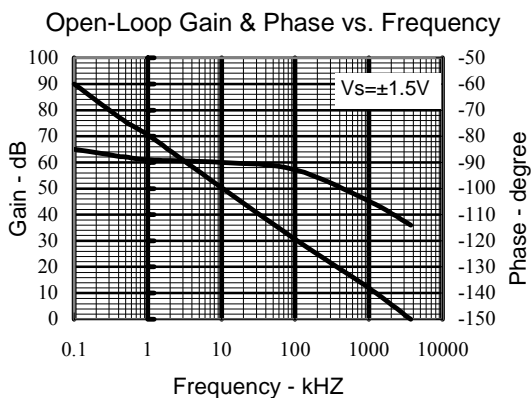

Test Condition: $V_S = \pm 1.5\text{V}$, $T_A = 25^\circ\text{C}$

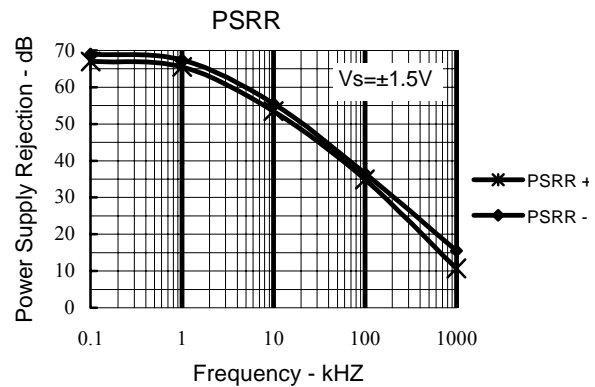

Package Information

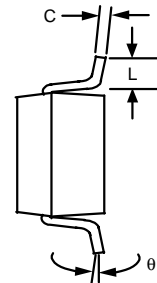
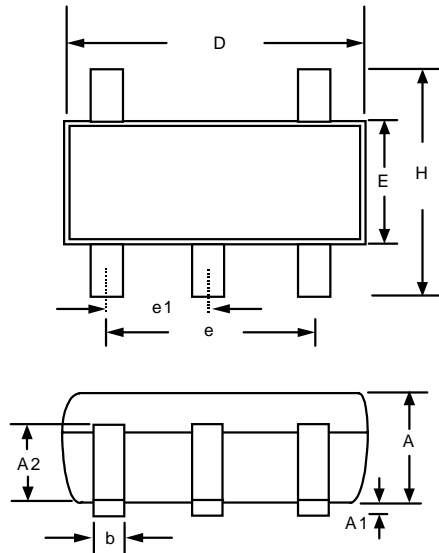

Taping Specification (Unit: mm)

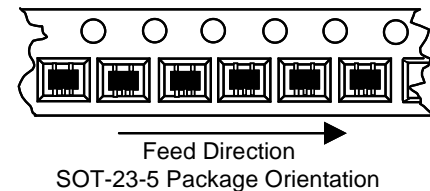
Note:

1. Package body sizes exclude mold flash protrusions or gate burrs
2. Tolerance ± 0.1000 mm (4mil) unless otherwise specified
3. Coplanarity: 0.1000mm
4. Dimension L is measured in gage plane

SYMBOLS	DIMENSIONS IN MILLIMETERS		
	MIN	NOM	MAX
A	1.00	1.10	1.30
A1	0.00	-----	0.10
A2	0.70	0.80	0.90
b	0.35	0.40	0.50
C	0.10	0.15	0.25
D	2.70	2.90	3.10
E	1.40	1.60	1.80
e	-----	1.90(TYP)	-----
e1	-----	0.95	-----
H	2.60	2.80	3.00
L	0.37	-----	-----
$\theta 1$	1°	5°	9°

Information furnished by Silicon Standard Corporation is believed to be accurate and reliable. However, Silicon Standard Corporation makes no guarantee or warranty, express or implied, as to the reliability, accuracy, timeliness or completeness of such information and assumes no responsibility for its use, or for infringement of any patent or other intellectual property rights of third parties that may result from its use. Silicon Standard reserves the right to make changes as it deems necessary to any products described herein for any reason, including without limitation enhancement in reliability, functionality or design. No license is granted, whether expressly or by implication, in relation to the use of any products described herein or to the use of any information provided herein, under any patent or other intellectual property rights of Silicon Standard Corporation or any third parties.